

OPERATING, CARE AND MAINTENANCE INSTRUCTIONS



Contents

0	Preface	5
1	Avoidance of risks	6
2	Avoidance of misuse	7
3	Operation	8
3.1	Turn-tilt element	8
3.2	Tilt-before-turn element	9
3.3	Safety device to deter incorrect operation	10
3.4	Rotary handle turn-tilt element.....	11
3.5	Side-hung element	12
3.6	Side-hung element, opening out	13
3.7	Second sash element.....	14
	3.7.1 Active sash with turn-tilt and second sash with side-hung function.....	14
	3.7.2 Active and second sash with side-hung function.....	15
3.8	Bottom-hung element.....	16
	3.8.1 Bottom-hung window at parapet height.....	16
	3.8.2 Bottom-hung fanlight element.....	18
3.9	Top-hung element (opening out).....	20
3.10	Top-hung projecting out element	21
3.11	Top-hung roof element.....	22
3.12	Pivoting sash window.....	23
3.13	Parallel sliding and tilting element (PSK)	24
3.14	Sliding element	26
3.15	Lifting-sliding element.....	27
3.16	Opening limiter	28

3.17	Window handles, lockable.....	29
3.18	Partial ventilation.....	30
3.19	Balcony door latch	31
3.20	Security lock.....	32
3.21	Door locks	33
	3.21.1 with latch locking unit.....	33
	3.21.1.1 Wilka – „controlled latch locking“	33
	3.21.1.2 BKS – „secured latch locking“	34
	3.21.2 Door locks with escape door function	35
4	Upkeep of aluminium components	37
4.1	Cleaning - Definitions and terms	37
4.2	Cleaning prescriptions	38
	4.2.1 Anodized surfaces.....	38
	4.2.2 Plastic-coated surfaces.....	39
4.3	Supplementary care instructions.....	40
5	Maintenance	41
5.1	Functional check and maintenance of fittings.....	42
5.2	Cleaning of the drainage slots	44
5.3	Care and maintenance of gaskets	44
5.4	Cleaning the roller guides of lifting-sliding and sliding elements.....	45
5.5	Lubrication points on parallel sliding and tilting elements (PSK)	46
5.6	Door locks and cylinder locks.....	47
5.7	Door hinges	47

6	Room climate	48
6.1	Healthy living	48
6.2	Correct ventilation.....	50
7	Maintenance and repair by specialist companies	52
7.1	Maintenance check book.....	52
8	Information and advice	53
	Index	54

0 Preface

We are glad that you have decided to purchase a high-quality product manufactured by Hueck!

This brochure contains hints and information on the operation, care and maintenance to help you maintain the value of your Hueck products for a long time.

A specialised company ensures that your windows and doors are assembled professionally. Furthermore, this company provides you with qualified consulting service and assistance with adjustments, maintenance and repairs.

→ An online version of this catalogue can also be found on the Internet at www.hueck.com

1 Avoidance of risks

Please observe the warning notices listed below:

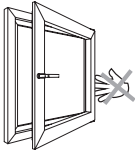

Risk of injury through getting pinched in the opening gap between window sash or door leaf and frame



Danger of falling if sashes are open



Danger of falling or risk of injury, e.g. caused by draughts



Risk of injury if sashes are open



Risk of injury through sash impact

2 Avoidance of misuse

Avoid damage to your window, window door or door elements by making sure that they are only used as intended:

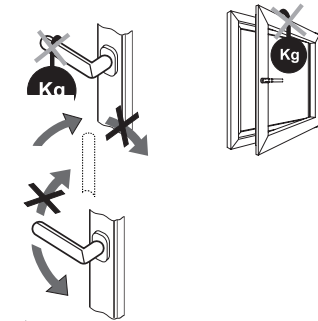

Load on the sashes or leaves can cause deformation to or destruction of the individual elements.

Operate the element handles only in the direction of rotation and only up to the rotation stop as they will be destroyed otherwise.

Sashes or leaves banging open or shut in an uncontrolled manner (e.g. caused by wind) against wall recesses can damage the frame, fittings or the recess. Recommendation: use opening limiter (regulates the opening) or door stop.

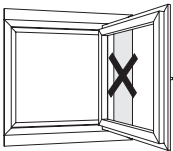

Obstacles (e.g. cables, flower pots) in the opening area between sash/leave and frame cause deformation and damage to frames and fittings.



Do not push the door closed when the bolt is pre-locked: this will protect the lock and the door frame.



In case of double-leaf elements, the active leaf must always be opened first (exception: escape doors) to avoid damage to the lock or frame.



- 1 Active leaf
- 2 Inactive leaf

3 Operation

The following operating instructions apply to all types of elements.

In case of new rebate gaskets, increased effort may be required for the necessary closing pressure.

3.1 Turn-tilt element

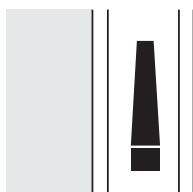

Bottom-hung position

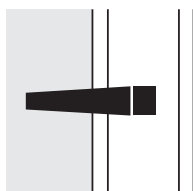
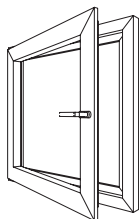

Side-hung position

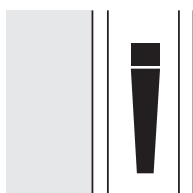

Locked position

3.2 Tilt-before-turn element

This opening type is preferred in schools and hospitals, due to the fact that a lockable handle prevents the window from being opened completely by unauthorised persons. The window is only tilted for ventilation purposes.

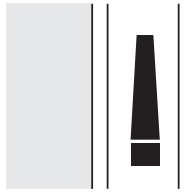

Side-hung position

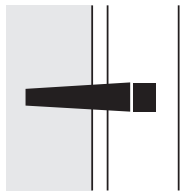

Bottom-hung position

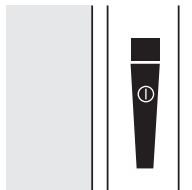
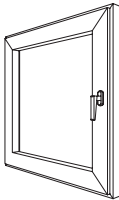

Locked position

3.3 Safety device to deter incorrect operation

A safety device to deter incorrect operation prevents the activation of the bottom-hung position as long as the sash is in sidehung position. It is located in the handle area or at the corner linkage gear. If the safety device to deter incorrect operation does not work, a specialist company must be contacted.

3.4 Rotary handle turn-tilt element

The red indicator shows the current position of the fitting.

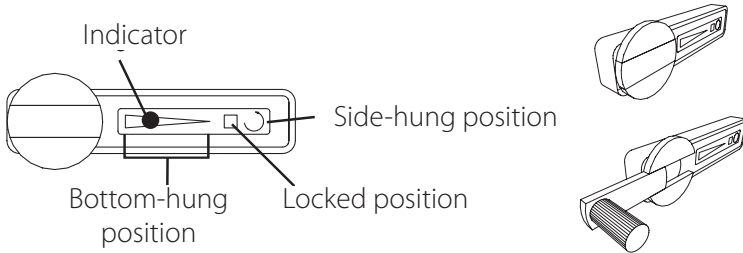

Opening in bottom-hung position

Turn the rotary handle folded out of the turn knob to the left until the desired opening angle is reached.

Closing from bottom-hung position

Turn the rotary handle to the right until locking is indicated.

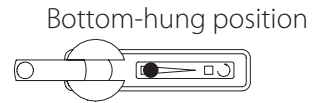
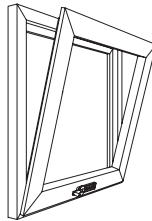

Opening in side-hung position

Turn the rotary handle to the right until the red indicator shows the side-hung position, then open the sash.

Closing from side-hung position

Press the sash and turn the rotary handle to the left until locking is indicated.

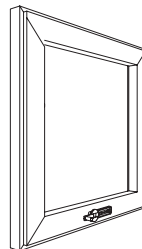
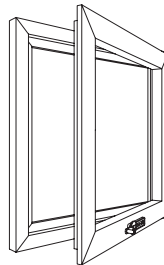

3.5 Side-hung element

The window sash can only be turned. A handle position with the handle pointing upwards is not possible.

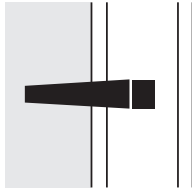

Side-hung position

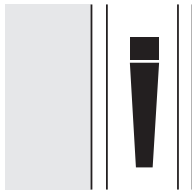
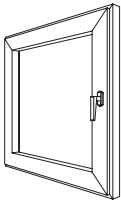

Locked position

3.6 Side-hung element, opening out

The window sash can only be turned to the outside. A handle position with the handle pointing upwards is not possible.
An opening limiter (regulates the opening) is recommended.

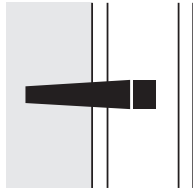

Side-hung position

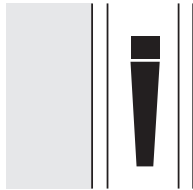

Locked position

3.7 Second sash element

3.7.1 Active sash with turn-tilt and second sash with side-hung function

Opening the second sash

Open the active sash in the side-hung position, unlock the lever at the second sash and open the second sash.

Closing the second sash

Reverse order

Handling of the sash in use:

inactive sash active sash

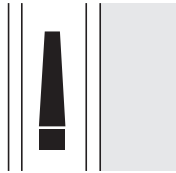
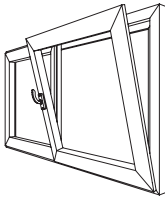
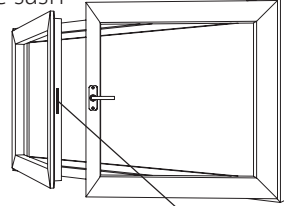

Bottom-hung position

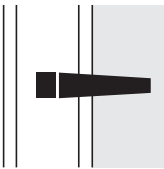
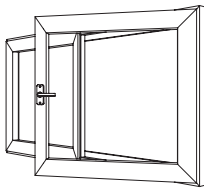

Side-hung position

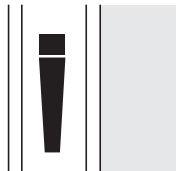
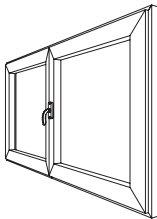

Locked position

3.7.2 Active and second sash with side-hung function

Opening the second sash

Open the active sash in the side-hung position, unlock the lever at the second sash and open the second sash.

Closing the second sash

Reverse order

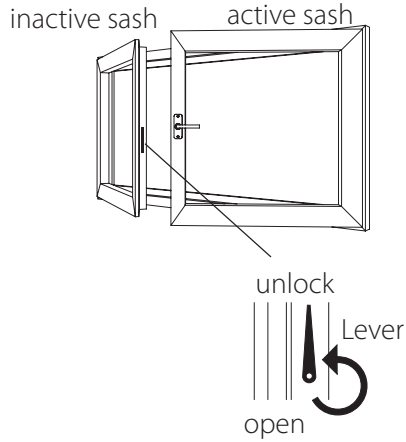

Handling of the sash in use:

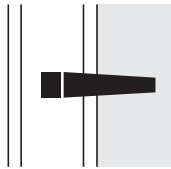
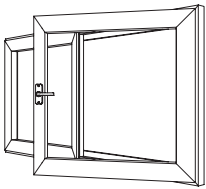

Side-hung position

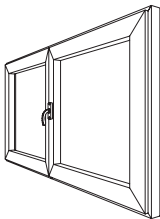

Locked position

3.8 Bottom-hung element

As a basic principle, bottom-hung sashes are secured against uncontrolled slamming open by means of KSP stay-arms (tilt safety cleaning stay-arms). These are unhinged for cleaning the windows. ATTENTION! There is an increased risk of accident. The opened sash must be supported. For unhinging, move the sash into the bottom-hung position, open the locking device and unhinge the stay-arm.

Two variants of bottom-hung windows are possible:

3.8.1 Bottom-hung window at parapet height

Window handle located at the top

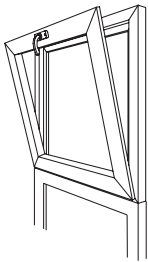

Bottom-hung position

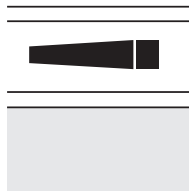
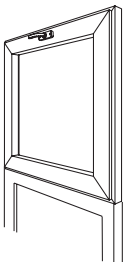

Locked position

Window handle located on the side

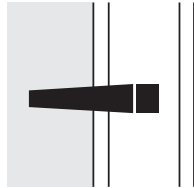

Bottom-hung position

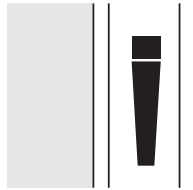

Locked position

3.8.2 Bottom-hung fanlight element

There are three common operating types:

1. Lever
2. Rotary handle
3. Electric drive

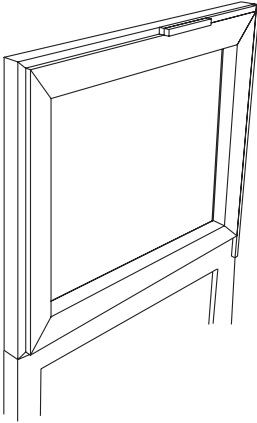

Locked position

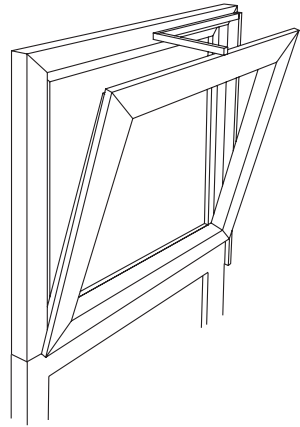

Opened position

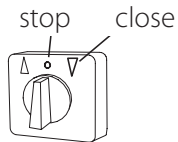
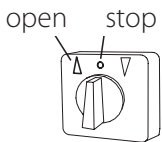
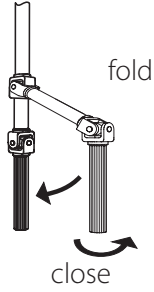
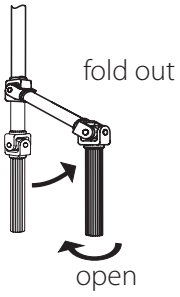
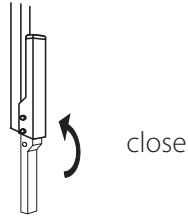
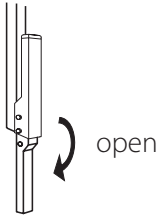

3.9 Top-hung element (opening out)

A handle position with the handle pointing upwards is not possible. The opened sash must be arrested.

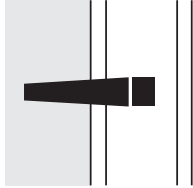
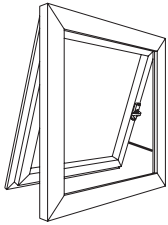

Top-hung position

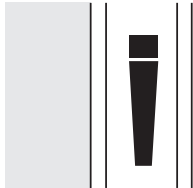
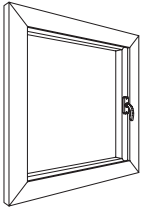

Locked position
and
Arrested position

3.10 Top-hung projecting out element

This opening type is predominantly used for façades.

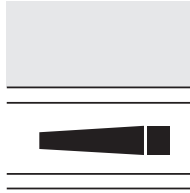
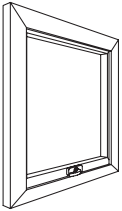

Locked position

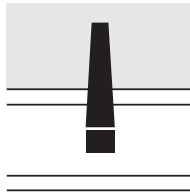
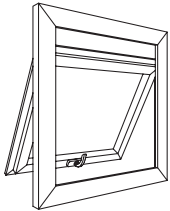

Bottom-hung position

3.11 Top-hung roof element

Stepless opening by means of spindle or chain drives.

Please observe the operating and maintenance information provided by the drive manufacturer.

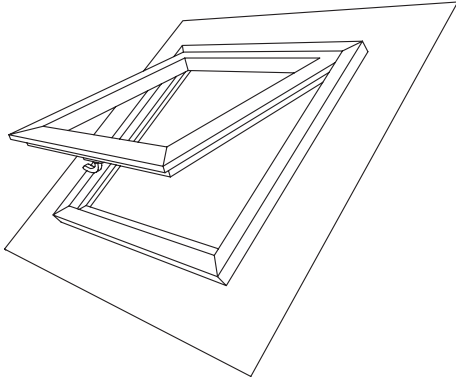

3.12 Pivoting sash window

Brakes located in the pivot bearings keep the sash open in every position. By means of the window handle, the sash can also be arrested in the gap position. An opening limiter can be used to limit the opening angle of the pivoting sash.

ATTENTION: If the sash can be moved too easily, the brakes must be re-adjusted by a specialist company. Pivot bearings must not be greased or lubricated.

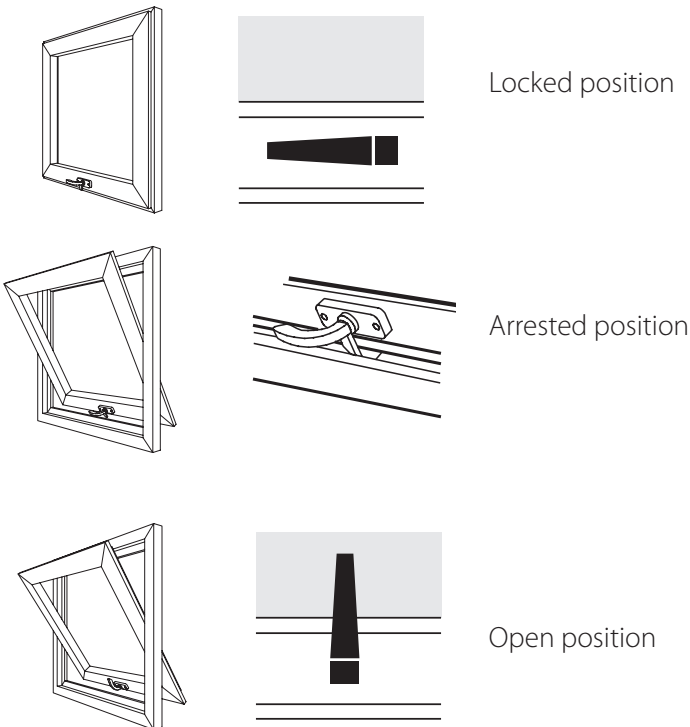

Arresting the pivoting sash

Open the pivoting sash, turn the handle to the horizontal position and turn the handle tenon into the locking pocket of the frame.

3.13 Parallel sliding and tilting element (PSK)

The PSK fitting for sash weights of up to 180 kg is equipped with an assisted opening function (if slid closed, the sliding function automatically locks), the fitting for sash weights of up to 100 kg has no assisted opening function.

with assisted opening function



Bottom-hung position

Schieben

Sliding unlocking device:
The sash can be opened with the handle in this position (from tilting to sliding position).

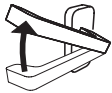

Sliding position:
The sash can be slid with the handle in horizontal position. Furthermore, the sash returns to the tilting position with the handle in this position if the sash is slid back into its original position.



Locking position:
Sash is closed by turning the handle. Sash may not be pressed on with additional force as this can cause damage!

without assisted opening function



Bottom-hung position

Schieben

Sliding unlocking device:
The sash can be opened with the handle in this position (from tilting to sliding position).



Sliding position:
The sash can be slid with the handle in horizontal position. Furthermore, the sash returns to the tilting position with the handle in this position if the sash is slid back into its original position.



Locking position:
Press on sash and bring it in locking position.

As a general rule:

The end stops serve as opening limit and may not be used for stopping the sliding sash abruptly. Otherwise there is the risk of damaging the material!

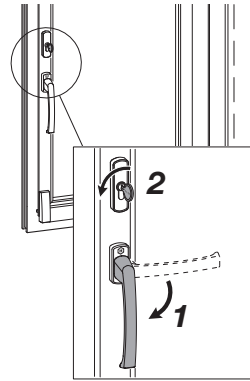

3.14 Sliding element

Sliding elements are equipped with a handle or a recessed grip with which the sash is operated.

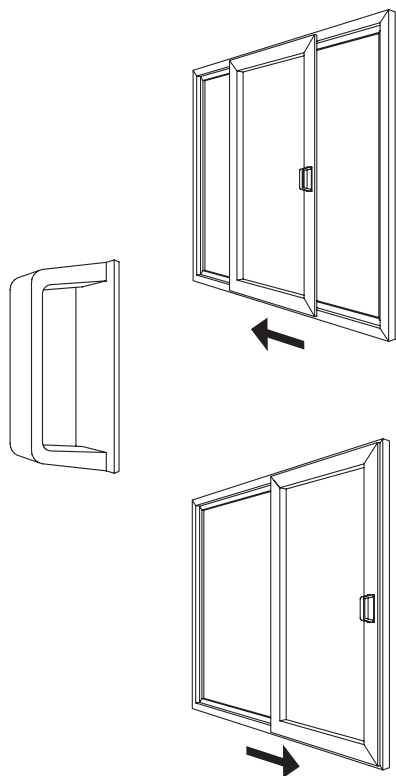

3.15 Lifting-sliding element

If the window handle is turned by 180° from upward to downward position into the sliding position, the sash is raised by several millimetres. In order to close the sash, slide it into the closed position and lower it again by turning the handle by 180° from the downward to the upward position.

Operation by means of handle set:

Sliding position

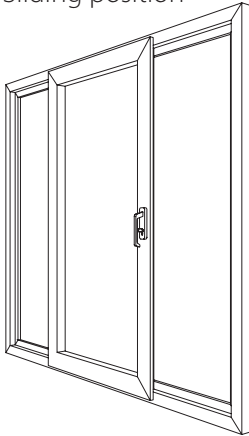

2. turn downwards

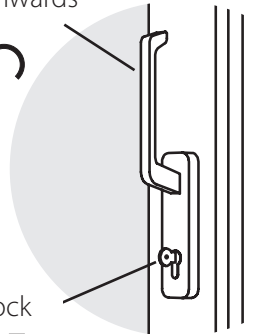

1. unlock

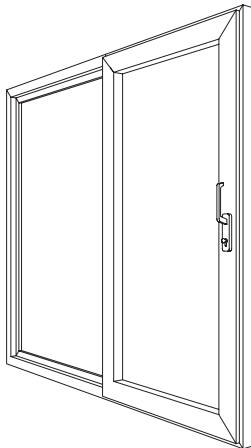

Locked position

3.16 Opening limiter

Opening limiters are force-absorbing (retarded opening movement) and restrict the sash's opening angle in various installation sizes to a maximum of 90°. They are maintenance-free and must not be lubricated.

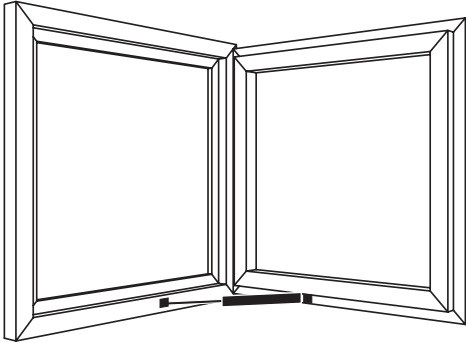

3.17 Window handles, lockable

Lockable window handles offer no adequate protection in accordance with the standards relating to burglar protection. They can be locked in every final position (tilt-before-turn handle can only be locked in side-hung position!). The keys are always of the same cylinder system.

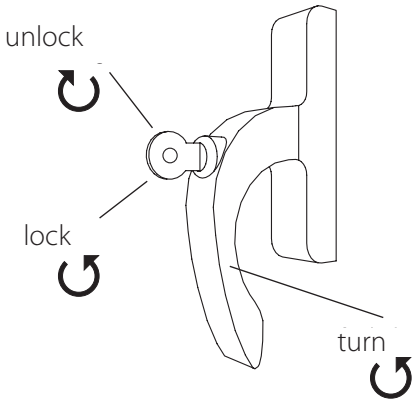

If exchanging Hueck window handles (also called turning handles or handle gears) please observe the typical features:

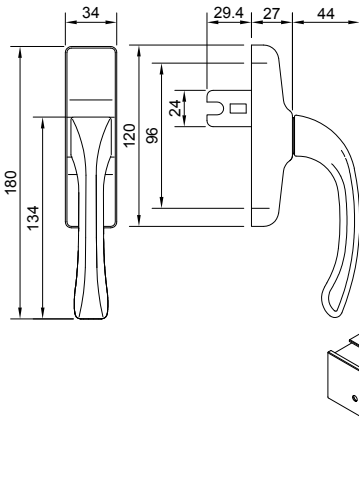

Gauge for fixing drill hole: 96 mm
 Shape of lever guide: cf. illustration

Punching scheme for the handle notch

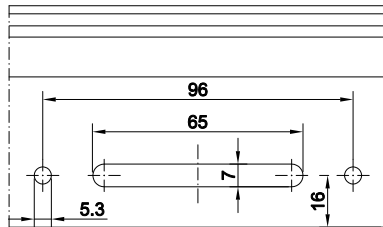

3.18 Partial ventilation

The exposed partial ventilation device arrests the window sash for permanent ventilation with a gap of approx. 4 mm by tilting the fish plate.

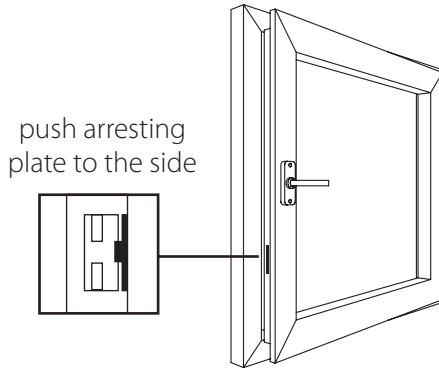

3.19 Balcony door latch

Keeps a balcony door closed by slight latching.

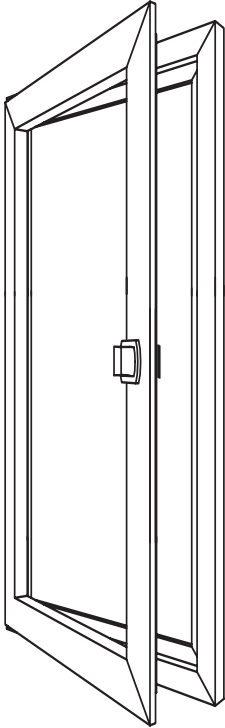

3.20 Security lock

Locks the side-hung opening position of the element sash, but not the bottom-hung position.

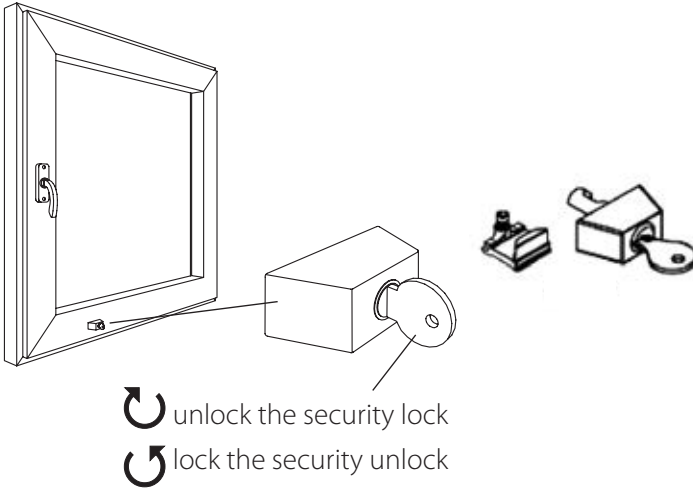

3.21 Door locks

3.21.1 with latch locking unit

As an alternative to electric openers with manual daytime unlocking, the latch can be retracted and locked in these door locks.

3.21.1.1 Wilka – „controlled latch locking“

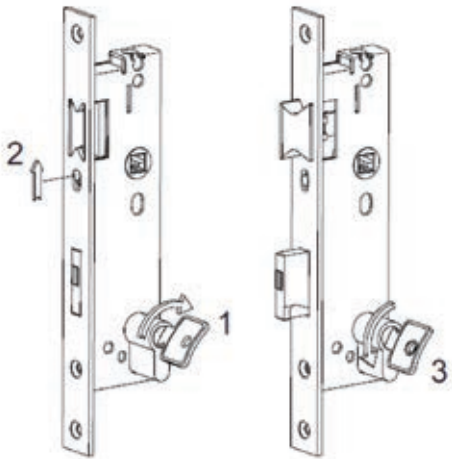

The latch bolt is retracted with the key via the transmission (1).

In this position, the latch retainer can be pushed up (2).

Now the latch bolt is held inside the lock case, permitting uninterrupted passage.

The retracted latch is released by projecting the dead bolt (3).



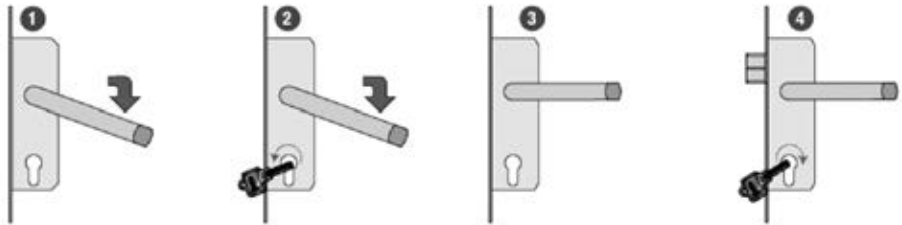















3.21.1.2 BKS – „secured latch locking”









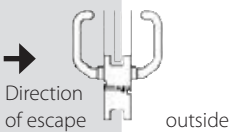

Note: Not admissible for fire and smoke protection doors.

- (1) The latch is retracted by means of the handle (push bar).
- (2) In this position, the locking function must be set by means of the suitable key.
- (3) Now the latch is locked in the retracted position.
- (4) The secured latch locking can only be released by activating the transmission once again.

3.21.2 Door locks with escape door function

	 Direction of escape outside		 Direction of escape outside		Fixed knob or handle outside
Closing status of the door	Opening possibilities for doors				
	Change-over function B		Change-over function E		
	from inside	from outside	from inside	from outside	
simply closed (only the latch has snapped) 	handle opens 	handle opens 	handle opens 	only key opens 	
locked (lock bolt is pre-locked) 	panic: handle opens 	handle idle (nur Schlüssel öffnet) 	Panikfunktion: handle opens 	only key opens 	
Opening possibility following panic operation 	handle opens 	handle idle (only key opens)   After the use of the anti-panic function, the lock has to be returned to the neutral position: Insert key, make ¼ turn into the direction of the arrow and back, remove key (transmission).	handle opens 	only key opens 	

			
		Opening possibilities for doors	
Closing status of the door		Through-function D	
		from inside	from outside
simply closed (only the latch has snapped) 	handle opens 	handle opens 	
locked (lock bolt is pre-locked) 	panic:: handle opens 	Neutral position of the handle (opens only key)	
Opening possibility following panic operation from the inside 	handle opens 	handle opens  i.e. access to the endangered room is still possible. People still inside can be rescued.	

4 Upkeep of aluminium components

Regular cleaning is a fundamental requirement for the longevity and appearance of high-grade profile surfaces and the functionality of components.

Information on maintenance can be found in chapter 5.

4.1 Cleaning - Definitions and terms

The required cleaning measures are defined depending on the degree of pollution of the aluminium components or the result of a test cleaning:

- Initial cleaning
carried out following the completion of construction prior to final acceptance in order to remove pollution caused by the construction process or atmospheric influences.
- Basic cleaning
is an abrasive cleaning process which might be required if a façade has not been cleaned for several years.
- Intermittent cleaning
is a periodic cleaning following initial cleaning or basic cleaning. It is offered by specialist companies working in line with state-of-the-art knowledge and methods.

4.2 Cleaning prescriptions

Minor soiling on anodized or plastic-coated surfaces can be removed with a sponge, soft cloth and water.

A neutral surfactant (washing-up liquid) will be a sufficient detergent. It is rinsed thoroughly with water after cleaning. Suds must not be used as their alkalinity is too high.

4.2.1 Anodized surfaces

The detergent must not chemically attack artificial oxide surfaces. It must have a neutral pH value between 5 and 8.

Strongly abrasive or scouring devices or devices causing scratches (sandpaper, sandblasting, wire brush, etc.) will damage the oxide surface as well and thus must not be used. Special detergents developed by the chemical industry help to prevent these risks if used properly:

Degree of pollution	light	medium	heavy	oily
Neutral surfactant (washing-up liquid) and water	X			
Abrasive detergent, type Ia, Ib (1)		X	X	
Detergent, non-abrasive, with preserving agent	X	(X)	(X)	X
Special detergent, non-abrasive, type II (2)			X	X

- (1) Type Ia: Abrasive detergent or non-woven fabric, e.g. Scotch-Brite, type A, dirt eraser
Type Ib: Abrasive detergent with preservation
- (2) Type II: Special detergent (including solvent for oils and fat)

High-pressure cleaners may be used depending on the window or façade construction. In this case, no water must enter into the façade; observe the natural drainage direction of the façade construction and the applicable working and protective provisions.

Direct sunlight should be avoided during cleaning.

4.2.2 Plastic-coated surfaces

Similar to anodized surfaces, heavily soiled painted surfaces require more extensive basic cleaning. Paint often tends to chalk in the course of years. Such chalking can be removed by slightly abrasive detergents comparable to car polish. The detergents must be adjusted to the paint system.

4.3 Supplementary care instructions

Specialist firms offer appropriate, environmentally friendly façade cleaning.

The following items must not be used for cleaning:

- Hard objects such as metal scrapers, blades, wire brushes, scouring pads, steel wool etc. These will cause irreversible damage to the element surface.
- Aggressive detergents and solvents, e.g. paint thinner or benzene, acids or brine (with pH values outside the range of 5-8), rough detergents such as scouring milk may cause irreversible damage to the surface.

Further technical information on cleaning and maintaining aluminium construction profiles can be found in our "Technical Information" at www.hueck.de (under the heading "Metalwork Shops" -> "Care and maintenance") or in the leaflets issued by the VFF (Verband der Fenster- und Fassadenhersteller e.V. [Association of window and façade manufacturers]) at www.window.de

5 Maintenance

Windows and doors should undergo regular maintenance in order to prolong their service life and to ensure the functionality and the conservation of value.

The window institute ift Rosenheim issued a recommendation concerning inspection intervals:

Maintenance intervals	Security-relevant inspection	General inspection
School or hotel buildings	1 x per half-year	1-2 x per year
Office or public buildings	1-2 x per year	1 x per year
Residential buildings	every 1-2 years	upon request

Special maintenance recommendations apply to fire and smoke protection doors. These can be found at www.hueck.de in the installation, planning and maintenance instructions in the fire protection catalogue.

Depending on environmental influences, annual maintenance is recommended for parallel sliding and tilting elements. Regular professional maintenance should be carried out especially in coastal areas up to approx. 30 km upcountry with and without aggressive industrial atmosphere, in a polluted industrial environment but also in swimming baths and/or in baths with thermal salt water.

5.1 Functional check and maintenance of fittings

On the occasion of the functional check, the fitting parts and their load-bearing functions must be checked regularly for soiling, wear and tear and tightness. Heavy soiling is to be removed promptly (information on this topic can be found in the chapter “Cleaning”).

The building components are checked for damage and deformation. In this context, surfaces, gaskets, door hinges and fitting components must be considered. They are relevant with regard to security and must be checked with particular care. If metal shavings are visible, a specialist company must be contacted immediately. If required, the fixing screws of the fittings must be tightened and secured against automatic loosening, e.g. by safety paint. Defective building components must be replaced immediately by a specialist company.

Fittings mounted in plastic bushes must not be lubricated or oiled. As a basic principle, fitting adjustments should only be carried out by specialist companies. Movable components should be lubricated once or twice a year.

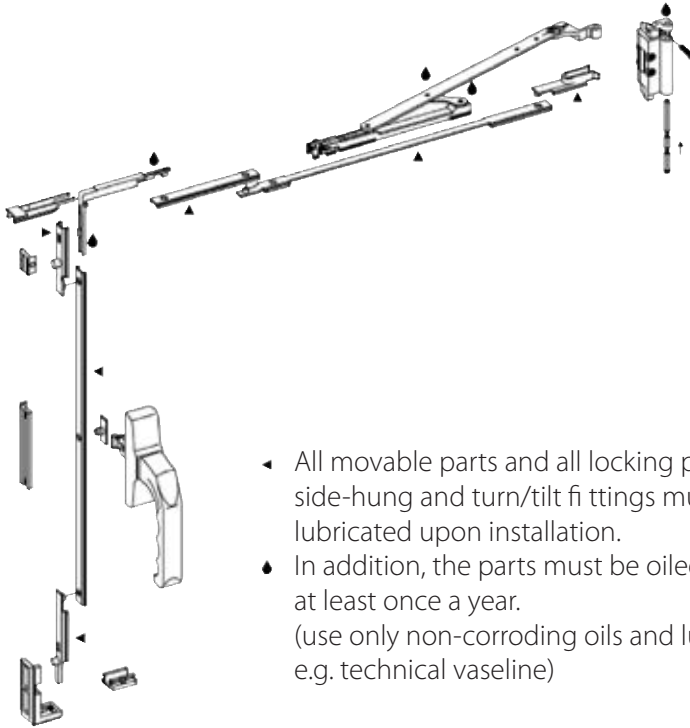

- ◀ All movable parts and all locking points of the side-hung and turn/tilt fittings must be lubricated upon installation.
- ◆ In addition, the parts must be oiled or lubricated at least once a year.
(use only non-corroding oils and lubricants, e.g. technical vaseline)

An optical check should be carried out to examine the recess joints, among other things. Thus it can be easily seen if a sash is “crooked”.

The glazing is checked for condensation, moisture in between the panes and cracks. In case of such problems, the glazing must be replaced by a specialist company.

5.2 Cleaning of the drainage slots

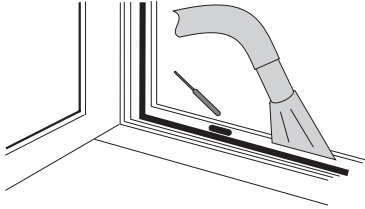

Dust and dirt should be removed from between the gaskets and the outsides of the frame with a cloth or vacuum cleaner.

Clogged drainage slots / drill holes can be cleaned with a thin wooden or plastic stick.

5.3 Care and maintenance of gaskets

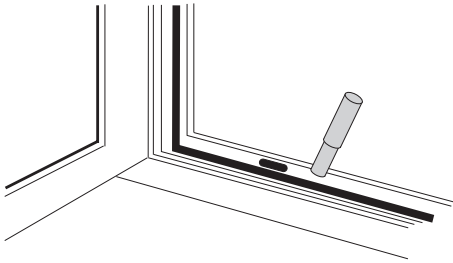

The gaskets of windows and doors can be easily cleaned with water. Apart from normal cleaning, a silicone stick or a polymer lubricant – depending on the gasket variant – should be applied regularly to the gaskets to maintain their elasticity and to prevent premature embrittlement of the gaskets. On this occasion, you should check the gaskets for damage and have damaged gaskets replaced by a specialist company.

5.4 Cleaning the roller guides of lifting-sliding and sliding elements

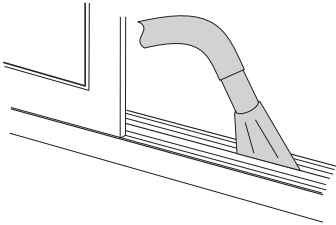

A vacuum cleaner can be used to remove dust and dirt from the roller guides.

5.5 Lubrication points on parallel sliding and tilting elements (PSK)

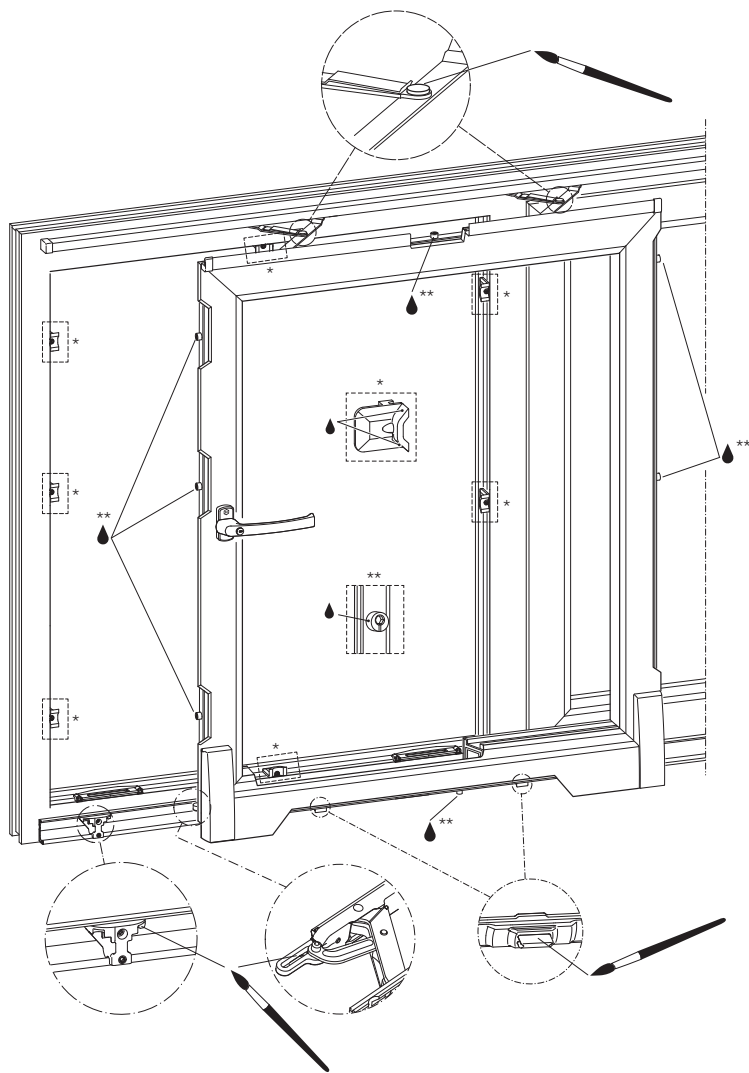

5.6 Door locks and cylinder locks

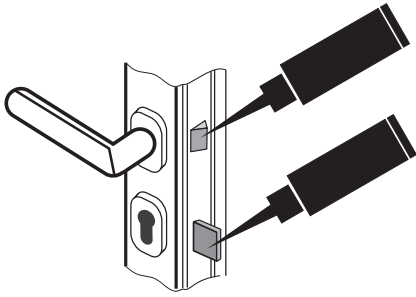

Bolt and latch of the door lock must be lubricated regularly.

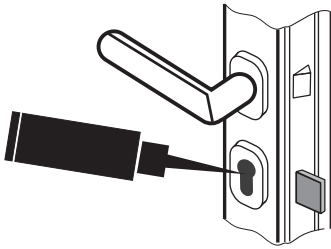

Use only graphite powder for lubricating the cylinder lock.

5.7 Door hinges

All repair and adjustment works at barrel, screw-on or concealed door hinges should be carried out by a specialist company.

6 Room climate

6.1 Healthy living

Regular correct ventilation and heating improves the quality of air in your rooms and thus significantly contributes to a comfortable, healthy room climate.

Today, modern windows and doors are “tighter” than in the past and enable less exchange of air between the outside and inside. This means that regular ventilation has become more important as on account of the great tightness of the windows, no joint ventilation takes place anymore. A regular exchange of air can avoid damage caused by too high humidity, such as

- formation of mildew with long-term consequences for humans,
- moisture penetration through the brickwork,
- damage to the basic structure of the building,
- deterioration of the room climate.

There are many sources of humidity in living and working rooms that constantly produce considerable amounts of water vapour.

In the course of one day, for example, a 4-person household releases up to 10 litres of water to the ambient air.

	Humidity released per day
Human being	1.0 – 2.0 litres
Cooking	0.5 – 1.5 litres
Shower/bath (per person)	0.5 – 1.0 litres
Drying laundry	1.0 – 2.5 litres
Ornamental and potted plants	0.5 – 1.0 litres

The humidity condenses in rooms on surfaces with a low surface temperature. This condensation may lead to moist walls, formation of mildew, mould stains or deterioration of plaster.

In order to discharge the arising humidity, it is crucial to ventilate the rooms several times a day. This can avoid damage caused by the formation of condensate.

6.2 Correct ventilation

In order to avoid damage caused by dampness and the formation of mildew at building elements, all rooms, in particular rooms with a high degree of humidity such as kitchens and bathrooms, should be ventilated thoroughly. For example, ventilation should be ensured during cooking at the time when water vapour is created.

The exchange of air should take place quickly to avoid the loss of too much thermal energy and a cooling down of walls and furnishing. Thus the objective of ventilation is a complete exchange of the air inside the room with the outside air. The duration varies according to the type of ventilation and the season.

This means that by cross ventilation, a quick, complete exchange of air with a relatively low consumption of heating energy can be achieved in only 5 minutes while 60 minutes of partial ventilation are required to achieve the same effect. Permanent ventilation (tilted window) should be avoided during the heating period.

Further ventilation guidelines should be observed:

- Renew the ambient air at regular intervals.
- Ensure thorough ventilation in the morning with the heating turned off depending on the season.
- The colder it is outside, the shorter the period of cross ventilation should be.
- Quick cross ventilation does not cool down walls and furniture.
- Do not block the radiation of heat from radiators by furniture or curtains.
- Immediately ventilate off water vapour set free in kitchen and bathroom.

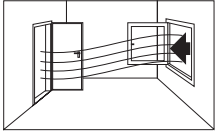
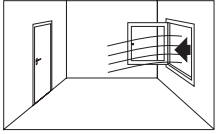
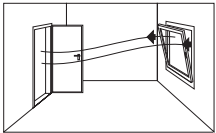
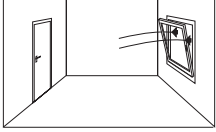
Eff ect of natural ventilation	Type of ventilation	Duration of ven-tilation required to achieve an exchange of air
	<p>Cross ventilation Window and opposing door/ window opened completely. Advantage: Ambient air is renewed within a short period of time while the room does not cool down. Energy loss is minimised, heating costs are saved.</p>	<p>1 to 5 minutes</p>
	<p>Shock ventilation Window opened completely and opposing door/window closed Advantage: The ambient air is renewed within a short period of time while the room does not cool down. Energy loss is minimised, heating costs are saved.</p>	<p>5 to 10 minutes</p>
	<p>Cross ventilation Window tilted and opposing door/ window opened completely Disadvantage: The room cools down and energy losses are high, high heating costs.</p>	<p>10 to 30 minutes</p>
	<p>Partial ventilation Window tilted and opposing door/ window closed Disadvantage: The room cools down and energy losses are high, high heating costs.</p>	<p>30 to 60 minutes</p>

7 Maintenance and repair by specialist companies

The conclusion of a maintenance contract with a specialist company ensures that all maintenance and repair work of your window and door elements is carried out at regular intervals.

7.1 Maintenance check book

Address of property

Name _____

Street _____

Postal code/City _____

System installed Lambda Volato M Lava
 Trigon Volato S

Detailed description _____

Maintenance works carried out

Date,	Company,	Signature

8 Information and advice

If you have further questions concerning Hueck products, please contact your domestic specialist supplier or refer directly to:

Hueck GmbH & Co. KG
Loher Straße 9
58511 Lüdenscheid
Tel. +49 2351 151-0
Fax +49 2351 151-283
www.hueck.com
E-Mail: info@hueck.com

Index

B		M	
Balcony door latch.....	31	Maintenance	41
BKS –		Maintenance and repair by specialist companies	52
„secured latch locking“	34	O	
Bottom-hung element.....	16	Opening limiter	28
Bottom-hung fanlight element.....	18	Operation	8
Bottom-hung window at parapet height.....	16		
C		P	
Care and maintenance of gaskets..	44	Parallel sliding and tilting element (PSK)	24
Cleaning of the drainage slots	44	Partial ventilation	30
Cleaning the roller guides of lifting- sliding and sliding elements	45	Pivoting sash window.....	23
Correct ventilation	50	Preface.....	5
D		R	
Door hinges	47	Rotary handle turn-tilt element.....	11
Door locks	33	S	
Door locks and cylinder locks.....	47	Safety device to deter incorrect operation	10
Door locks with escape door function	35	Second sash element.....	14
F		Security lock.....	32
Functional check and maintenance of fittings.....	42	Side-hung element.....	12
H		Side-hung element, opening out..	13
Healthy living	48	Sliding element.....	26
I			
Information and advice	52		
Incorrect use.....	7		

T

Tilt-before-turn element 9

Top-hung element (opening out).. 20

Top-hung projecting out element 21

Top-hung roof element..... 22

Turn-tilt element..... 8

U

Upkeep of aluminium components 37

V

Ventilation and second sash with
side-hung function 15

Ventilation sash with turn-tilt and
second sash with side-hung
function 14

W

Warning 6

Wilka –
„controlled latch locking“ 33

Window handles, lockable..... 29

ALUMINIUM SYSTEMS @
HUECK
GERMAN ENGINEERING SINCE 1814

HUECK GMBH & CO. KG

Loher Straße 9
58511 Lüdenscheid
T +49 2351 151-0
F +49 2351 151-283
info@hueck.com
hueck.com

Bitte hier stempeln Please stamp here

Aktuelle Informationen und umfangreiche Downloads finden Sie unter

Current information and a comprehensive download section can be found at [HUECK.COM](https://www.hueck.com)

Es gelten unsere allgemeinen „Verkaufs- und Lieferbedingungen“, die wir Ihnen auf Nachfrage gern zusenden oder die Sie auf unserer Internetseite finden. Our “General Terms and Conditions of Sale” apply which we will send you on request or which you find in the Internet at our domain.